

# HYTORC®

Since 1968



# LiON

## **OPERATIONS MANUAL**

This manual applies to all tool part numbers in the LION Product Families. The complete part number matrix which applies to this manual can be found in Appendix A and B respectively. It is recommended the manual is kept up-to-date by checking the edition and date code at the bottom of this page by utilizing the HYTORC website and downloading a copy of the most recent edition as needed.

**LION GUN PRODUCT FAMILY:**

LION-.25, LION-.7

**EN, EN-ISO, ISO Standards:**

EN ISO 12100-1:2011	EN 982:2009
EN ISO 12100-2:2011	EN 61310-2:2008
EN ISO 14121-1:2007	EN 61310-3:2008
EN ISO 11148-6:2012	ISO 3744:2011

*For a complete EC declaration of conformity or if you require any further assistance please contact your local HYTORC representative or 1-800-FOR-HYTORC (1-800-367-4986) or on the web at [www.hytorc.com](http://www.hytorc.com).*

HYTORC Corporate Headquarters  
333 Route 17 North  
Mahwah, NJ 07430, USA

**Notice:** *The information contained in this document is subject to change without notice. HYTORC makes no warranty of any kind with regard to this material, including but not limited to, the implied warranties of merchantability and fitness for a particular purpose. HYTORC shall not be liable for errors contained herein or for incidental or consequential damages in connection with the furnishing, performance, or use of this material. It is further recommended that the end-user or repair technician insure they have obtained and are familiar with the latest revision of the manual for the equipment outlined in this document.*

**Restricted Rights Legend:** *Use and duplication of the information contained within this manual is limited to the purchaser, end user, or licensed HYTORC representative. It is recommended that proper training for the equipment outlined in this manual be conducted by a HYTORC authorized training representative for any person who is operating or repairing the equipment outlined in this document. Modification, or disclosure by any other agency or representative is strictly forbidden.*

**Product Modifications:** *HYTORC Corporation DOES NOT ALLOW any of the products listed in this manual to be modified by any end user without exception. Should an application require a modification to the tool, or any of the standard accessories please consult with your local HYTORC representative and they will be able to obtain the assistance for any modification that may be required.*

**© Copyright HYTORC Corporation 2017:** *All Rights Reserved. Reproduction, adaptation, or translation without prior written permission is prohibited, except as allowed under the copyright laws.*

1st. Edition. Printed in USA. January 2017

Complies with standards publication BS EN 82079-1:2012



## OPERATIONS MANUAL CONTENTS

<b>LIMITED WARRANTY</b>	4
<b>IMPORTANT SAFETY INFORMATION</b>	
Personal Protective Equipment	5
LION Gun Safety Warnings	6
Reaction Assembly and Drive	8
Basic Safety Instructions for Handling	11
<b>IMPORTANT BATTERY PACK SAFETY INSTRUCTIONS</b>	12
<b>THE RBRC™ SEAL</b>	13
<b>OPERATION</b>	
General	15
<b>SETUP</b>	
Battery Pack Installation and Removal	16
Charging Procedure	16
LED	17
Power	18
Reaction Arm	18
Basic Operation	18
Setting Torque and Release Angle	19
Basic Function Description	19
<b>LION GUN OPERATION</b>	
Tightening	20
Loosening	20
<b>ACCESS MAIN AND SUB MENUS</b>	21
Operation	22
Job Data	24
System	27
Admin	28
Calibration	30
Shortcuts	31
<b>MAINTENANCE</b>	
Preventive Maintenance	32
<b>CALIBRATION</b>	33
<b>APPENDIX</b>	
LION Gun Block Diagram	34
LION Gun Dimensions	35

# LION

## LIMITED WARRANTY

**WE WARRANT THAT DURING THE WARRANTY PERIOD, THE PRODUCT WILL BE FREE FROM DEFECTS IN MATERIALS AND WORKMANSHIP. OUR RESPONSIBILITY FOR DEFECTIVE GOODS IS LIMITED TO REPAIR OR REPLACEMENT AS DESCRIBED BELOW IN THIS WARRANTY STATEMENT.**

**WE EXPRESSLY DISCLAIM ANY AND ALL IMPLIED WARRANTIES, INCLUDING WITHOUT LIMITATION THE WARRANTIES OF MERCHANTABILITY AND FITNESS FOR A PARTICULAR PURPOSE TO THE DURATION OF THIS EXPRESS LIMITED WARRANTY.**

**THE REMEDIES DESCRIBED HEREIN ARE YOUR SOLE AND EXCLUSIVE REMEDIES AND OUR ENTIRE LIABILITY FOR ANY BREACH OF THIS LIMITED WARRANTY. OUR LIABILITY SHALL UNDER NO CIRCUMSTANCES EXCEED THE ACTUAL AMOUNT PAID BY YOU FOR THE DEFECTIVE PRODUCT, NOR SHALL WE, UNDER ANY CIRCUMSTANCES, BE LIABLE FOR ANY CONSEQUENTIAL, INCIDENTAL, SPECIAL OR PUNITIVE DAMAGES OR LOSSES, WHETHER DIRECT OR INDIRECT.**

**THIS LIMITED WARRANTY GIVES YOU SPECIFIC LEGAL RIGHTS AND YOU MAY ALSO HAVE OTHER RIGHTS, WHICH VARY FROM STATE TO STATE. SOME STATES DO NOT ALLOW LIMITATIONS ON HOW LONG AN IMPLIED WARRANTY LASTS OR ALLOW THE EXCLUSION OR LIMITATION OF INCIDENTAL OR CONSEQUENTIAL DAMAGES, SO THE LIMITATIONS OR EXCLUSIONS DESCRIBED HEREIN MAY NOT APPLY TO YOU.**

**THE LIMITED WARRANTY CAN ALSO BE FOUND ONLINE AT [WWW.HYTORC.COM/LION/WARRANTY](http://WWW.HYTORC.COM/LION/WARRANTY) AND IN THE DOCUMENTATION WE PROVIDE WITH THE PRODUCT.**

**Who may use this warranty?** TORC LLC. ("TORC") located at 333 218 Island Road, Mahwah, New Jersey 07430 USA ("we" or "HYTORC") extend this limited warranty only to the individual who originally purchased the product ("you"). It does not extend to any subsequent owner or other transferee of the product.

**What does this warranty cover?** This This limited warranty covers defects in materials and workmanship of the LION Gun (the "product") for the Warranty Period as defined below.

**What does this warranty not cover?** This limited warranty does not cover any damage due to: (a) transportation; (b) storage; (c) improper use; (d) failure to follow the product instructions or to perform any preventative maintenance; (e) modifications; (f) unauthorized repair; (g) normal wear and tear; or (h) external causes such as accidents, abuse, or other actions or events beyond our reasonable control.

**What is the period of coverage?** This limited warranty starts on the date of your purchase and lasts for one (1) year (the "Warranty Period"). The Warranty Period is not extended if we repair or replace the product. We may change the availability of this limited warranty at our discretion, but any changes will not be retroactive.

**What are your remedies under this warranty?** With respect to any defective product during the Warranty Period, we will repair or replace such product or the defective part free of charge. We will also pay for shipping and handling fees to return the repaired or replacement product to you, if we elect to repair or replace the defective product.

**How do you obtain warranty service?** To obtain warranty service, you must call 800-447-TORC or email our Customer Service Department at [info@torc.com](mailto:info@torc.com) during the Warranty Period to obtain a Defective Merchandise Authorization ("DMA") number. No warranty service will be provided without a DMA number.

# IMPORTANT SAFETY INFORMATION

Read and understand this material before operating or servicing this equipment. Failure to understand how to safely operate this tool could result in an accident causing serious injury or death.

- Inspect all LION Gun components as they are removed from the shipping container. If damage is found to any component, contact the shipper immediately. Do not use the tool.
- Failure to follow correct tool usage could result in personal injury, co-worker injury, and/or damaged tools and equipment.
- Ensure your working area is clean and unobstructed before beginning work.
- LION maintenance and repair must be performed by a qualified technician.
- Modifying a LION Gun or accessory is dangerous and invalidates the warranty.
- Inspect the tool before each use. Have any obviously worn or damaged parts replaced.
- When not in use, store the LION Gun and accessories in the plastic storage case supplied with the tool. Do not expose the gun to high humidity or large temperature variations.

## Personal Protective Equipment

- Always wear the appropriate personal protective equipment when operating a LION Gun including gloves, safety goggles, hearing protection, hard hat, and safety shoes.



## LION Gun Safety Warnings:

**WARNING Read all safety warnings and all instruction.** Failure to follow the warnings and instructions may result in electric shock, fire, and/or serious injury.

**Save all warnings and instructions for future reference.**

### 1) Work Area Safety

- **Keep work area clean and well lit.** Cluttered or dark areas invite accidents.
- **Do not operate the LION Gun in explosive atmospheres, such as in the presence of flammable liquids, gases or dusts.** The LION Gun can create sparks which may ignite the dusts or fumes.
- **Keep children and bystanders away while operating the LION Gun.** Distractions can cause you to lose control.

### 2) Personal Safety

- **Stay alert, watch what you are doing and use common sense when operating the LION Gun. Do not use the LION Gun while you are tired or under the influence of drugs, alcohol, or medication.** A moment of inattention while operating the LION Gun may result in serious personal injury.
- **Use personal protective equipment. Always wear eye protection.** Protective equipment such as dust mask, non-skid safety shoes, hard hat, or hearing protection used for appropriate conditions will reduce personal injuries.
- **Prevent unintentional starting. Ensure the switch is in the off-position before connecting to power source and or battery pack, picking up or carrying the tool.** Carrying the LION Gun with your finger on the switch or energizing power tools that have the switch on invites accidents.
- **Remove any adjusting key or wrench before turning the LION Gun on.** A wrench or a key left attached to a rotating part of the LION Gun may result in personal injury.
- **Do not overreach. Keep proper footing and balance at all times.** This enables better control of the LION Gun in unexpected situations.
- **Dress properly. Do not wear loose clothing or jewelry. Keep your hair, clothing and gloves away from the moving parts.** Loose clothes, jewelry or long hair can be caught in moving parts.
- **If devices are provided for the connection of dust extraction and collection facilities, ensure these are connected and properly used.** Use of dust collection can reduce dust-related hazards.

### 3) LION Gun use and care

- **Do not force the LION Gun. Use the correct LION Gun for your application.** The correct LION Gun will do the job better and at a safe rate for which it is designed.
- **Do not use the LION Gun if the switch does not turn it on and off.** Any LION Gun that cannot be controlled with the switch is dangerous and must be repaired.
- **Disconnect the plug from the power source and/or the battery pack from the LION Gun before making any adjustments, changing accessories, or storing LION Gun.** Such preventive safety measures reduce the risk of starting the LION Gun accidentally.

- **Store idle LION Guns out of the reach of children and do not allow persons unfamiliar with the LION Gun or these instructions to operate the LION Gun.** LION Guns are dangerous in the hands of untrained users.
- **Maintain LION Guns. Check the misalignment or binding of moving parts, breakage of parts and any other condition that may affect the power of tool's operation. If damaged, have the LION Gun repaired before use.** Many accidents are caused by poorly maintained LION Gun.
- **Use the LION Gun and accessories in accordance with these instructions, taking into account the working conditions and the work to be performed.** Using the LION Gun for the operations different from those intended could result in a hazardous situation.

#### 4) Service

- **Have your LION Gun serviced by a qualified repair person using identical replacement parts.** This will ensure that the safety of the LION Gun is maintained.

## IMPORTANT BATTERY PACK INSTRUCTIONS

- **NEVER** drop the LION Gun battery.
- **NEVER** hit or puncture the battery.
- **DO NOT** splash or immerse in water or other liquids.
- **USE THE LION GUN ONLY WITH SPECIFICALLY DESIGNATED 18V BATTERY PACKS.**
- The LION Gun battery should be stored at 30 degrees or cooler. Batteries can only be used from -20C to 40C.
- **Do not incinerate the battery pack even if it is severely damaged or is completely worn out.** The battery pack can explode in a fire. Toxic fumes and materials are created when LION Gun battery packs are burned.
- **Do not charge or use the battery in explosive atmospheres, such as in the presence of flammable liquids, gases or dust.** Inserting or removing the battery from the charger may ignite dust or fumes.
- **If battery contents come into contact with the skin, immediately wash area with mild soap and water.**
- **If battery liquid gets into the eyes, rinse over the open eye for 15 minutes or until irritation ceases. If medical attention is needed, the battery electrolyte is composed of a mixture of liquid organic carbonates and lithium salts.**
- **Contents of opened battery cells may cause respiratory irritation.** Provide fresh air. If symptoms persist, seek medical attention.
- **Recharge the LION Gun only with the charger specified by the manufacturer.** A charger that is suitable for one type of battery pack may create as risk of fire when used with another battery pack.
- **Use the LION Gun only with specifically designated battery packs.** Use of any other battery pack may risk injury and fire.

- **When the battery pack is not in use, keep it away from other metal objects, like paper clips, coins, keys, nails, screws and other small metal objects that can make a connection from one terminal to another.** Shorting the battery terminals together may cause burns or a fire.
- **Under abusive conditions, liquid may be ejected from the battery; avoid contact. If contact accidentally occurs, flush it with water. If liquid contacts eyes, additionally seek medical help.** Liquid ejected from the battery may cause irritation or burns.

## Reaction Arm

Use the appropriately sized reaction arm based on your application. The LION Gun is usually supplied with a reaction arm in standard length. However, a custom reaction arm may have been delivered for your special application.



### **WARNING!**

Never modify a Reaction Arm! Changes in the reaction arm may lead to personal injury or damage to the tool.

### **NOTE:**

Reaction modifications result in loss of warranty for the reaction arm and the LION Gun. If you need a custom reaction arm, please consult with your local HYTORC dealer.

## Reaction Assembly and Drive

- Please clean the splined surface of the LION Gun before mounting the reaction arm.
- Slide the reaction arm over the square drive with the extension of the arm facing away from the tool.
- Press the lock button on the side of the reaction arm and slide onto the housing spline until it seats against the shoulder, then release the button.





**WARNING!**

Always attach the reaction arm so that the foot points away from the body of the gun. Incorrect installation of the reaction arm can cause the reaction arm to come into contact with your hand or other body parts causing injury.



Hold the button on the reaction arm while sliding it onto the splined section past the square drive and release the button once the arm is fully seated. Test the connection by attempting to pull the arm off without pushing the release button.



Secure the socket using a locking pin through the square drive and a retaining ring.



Store the reaction arm and LION gun in the tool box supplied after use and during work breaks.

## Basic Safety Instructions for Handling

Make sure the reaction arm sits directly in contact with a suitable immovable object before you start to tighten the nut.



- Keep all body parts from the reaction point.
- Make sure the operator is safe and secure in place before starting.
- Make sure the square drive is seated correctly and completely onto the socket.



### **WARNING!**

If the reaction arm is not firmly seated and in direct contact with an immovable object before the fastening process is started, serious injury may occur. Make sure that all body parts and clothing are clear from the reaction area during the bolting process. To eliminate the exposed reaction area please inquire about the HYTORC Washer with your local representative or dealer.



**WARNING:** Burn hazard. Battery liquid may be flammable if it's exposed to other liquids, air, spark or flame.

- Charge the battery packs only in battery chargers supplied for charging this product.
- DO NOT pack with conductive items.



**WARNING:** Never attempt to open the battery pack for any reason. If battery pack case is cracked or damaged, do not insert into charger or tool. Do not crush, drop, or damage battery pack. Do not use a battery pack or charger that has received a sharp blow, has been dropped or has been run over or damaged in any way (i.e. pierced with a nail, hit with a hammer, stepped on). Damaged battery packs should be returned to an authorized HYTORC service center for recycling.

**WARNING: Fire hazard. Do not store or carry battery so that metal objects can contact exposed battery terminals.** For example, do not place battery in aprons, pockets, tool boxes, product kit boxes, drawers with loose nails, screws, keys etc. **Transporting batteries can possibly cause fires if the battery terminals inadvertently come in contact with conductive materials such as keys, coins, hand tools and the like.**

**The US Department of Transportation Hazardous Materials Regulations (HMR) actually prohibit transporting batteries in commerce or on airplanes, (i.e. packed in suitcases and carry-on luggage).** When transporting individual batteries, make sure that the battery terminals are protected and well insulated from materials that could contact them and cause a short circuit. For any other concerns in regarding the transportation of LION batteries, consult your Transportation Carrier.

## THE RBRC™ SEAL

The RBRC™ (Rechargeable Battery Recycling Corporation) Seal on the LION Gun battery (or battery pack) indicates that the costs to recycle the battery (or battery pack) at the end of its useful life have already been paid by HYTORC.

The RBRC™ in cooperation with HYTORC and other battery users, has established programs in the United States to facilitate the collection of spent LION Gun batteries. Help protect our environment and conserve natural resources by returning the spent LION Gun battery to an authorized HYTORC service center for recycling. You may also contact your local recycling center for information on where to drop off the spent battery. RBRC™ is a registered trademark of the Rechargeable Battery Recycling Corporation.

## IMPORTANT BATTERY CHARGER SAFETY INSTRUCTIONS

**SAVE THESE INSTRUCTIONS:** This manual contains important safety instructions for battery chargers:

- Before using charger, read all instructions and cautionary markings on charger, battery pack and product using battery pack.



**WARNING:** Shock hazard. Do not allow any liquid to get inside charger.

**CAUTION:** Burn Hazard. To reduce the risk of injury, charge only torque gun batteries. Other types of batteries may burst causing personal injury and damage.

**CAUTION:** Under certain conditions, with the charger plugged into the power supply, the charger can be shorted by foreign material. Foreign materials of a conductive nature such as, but not limited to, steel wool, aluminium foil, or any buildup of metallic particles should be kept away from charger cavities. Always unplug the charger from the power supply when there is no battery pack in the cavity. Unplug charger before attempting to clean.

- **DO NOT attempt to charge the battery pack with any chargers other than the one in this manual.** The charger and battery pack are specifically designed to work together.
- **These chargers are not intended for any uses other than batteries supplied with LION and Lithium series guns as described in this manual.** Any other uses may result in risk of fire, electric shock or electrocution.
- **Do not expose charger to rain or snow.**
- **To disconnect charger, firmly grasp plug and remove. Do not disconnect the charger by pulling on the cord.**
- **Make sure the cord is located so that it will not be stepped on, tripped over, or otherwise subjected to damage or stress.**

- **Do not use an extension cord unless it is absolutely necessary.**
- **An extension cord must have adequate wire size (AWG) for safety. In general the larger the wire size the greater the capacity of the cable.**
- **Do not block any ventilation slots on charger power supply.**
- **Do not mount charger on wall or permanently fix charger to any surface.** The charger is intended to be used on a flat surface (i.e. table top, bench top).
- **Do not operate charger with damaged cord or plug.** Have any damaged plug or cord replaced immediately.
- **Do not operate charger if it has received a sharp blow, been dropped, or otherwise damaged in any way.**
- **Do not disassemble charger; take it to an authorized HYTORC service center when service or repair is required.**
- **This charger is designed to operate on standard household electrical power (100-240 VAC 50/60hz).**

# OPERATION

## General

Each 18V LION Gun is supplied completely assembled and ready for use. A full kit contains:

- LION Gun
- One 18V LION 4.1Ah Battery Pack
- 18V Battery Charger
- Battery Charger Power Supply
- Reaction Arm



## SETUP

### Battery Pack Installation and Removal

To install the battery pack into the tool handle, align the base of the tool with the rails in the tool handle and slide the battery pack firmly into the handle until you hear the lock snap in to place.

To remove the battery pack from the tool, press the release button (as shown below) and firmly slide the battery pack out of the tool handle.



### Charging Procedure

1. Plug the charger power supply into the charger cradle using the coax barrel.
2. Plug the charger power supply into an appropriate outlet before inserting a battery pack.
3. Insert the battery pack into the charger cradle. The charger is equipped with a two light charge indicator that will be either red or green according to the charged level of the battery pack.



4. The completion of the charge is indicated by a green light which also indicates an idle state. The pack is fully charged and may be used at this time or left on the charger.

### LED Indicators:

- |                    |                      |
|--------------------|----------------------|
| • No Battery       | Solid Green Light    |
| • Charging         | Blinking Green Light |
| • Fully Charged    | Solid Green Light    |
| • Short Circuit    | Flashing Red Light   |
| • Reverse Polarity | Flashing Red Light   |
| • Damaged Battery  | Flashing Red Light   |



## Power

The LION Gun battery charger can operate at 110V or 220V AC. The plug is configured for the required market.

## Reaction Arm

Each LION Gun is equipped with a universal reaction arm. The reaction arm is used to absorb and counteract any opposing forces created by the operation of the gun. Use the appropriately sized reaction arm or HYTORC Washer based on your application.

## Basic Operation

Press any button to start the gun. The gun will shut itself off after 3 minutes of inactivity. See the image below for the LION Gun's Main Screen Display. All gun parameters will be saved from the most recent session.

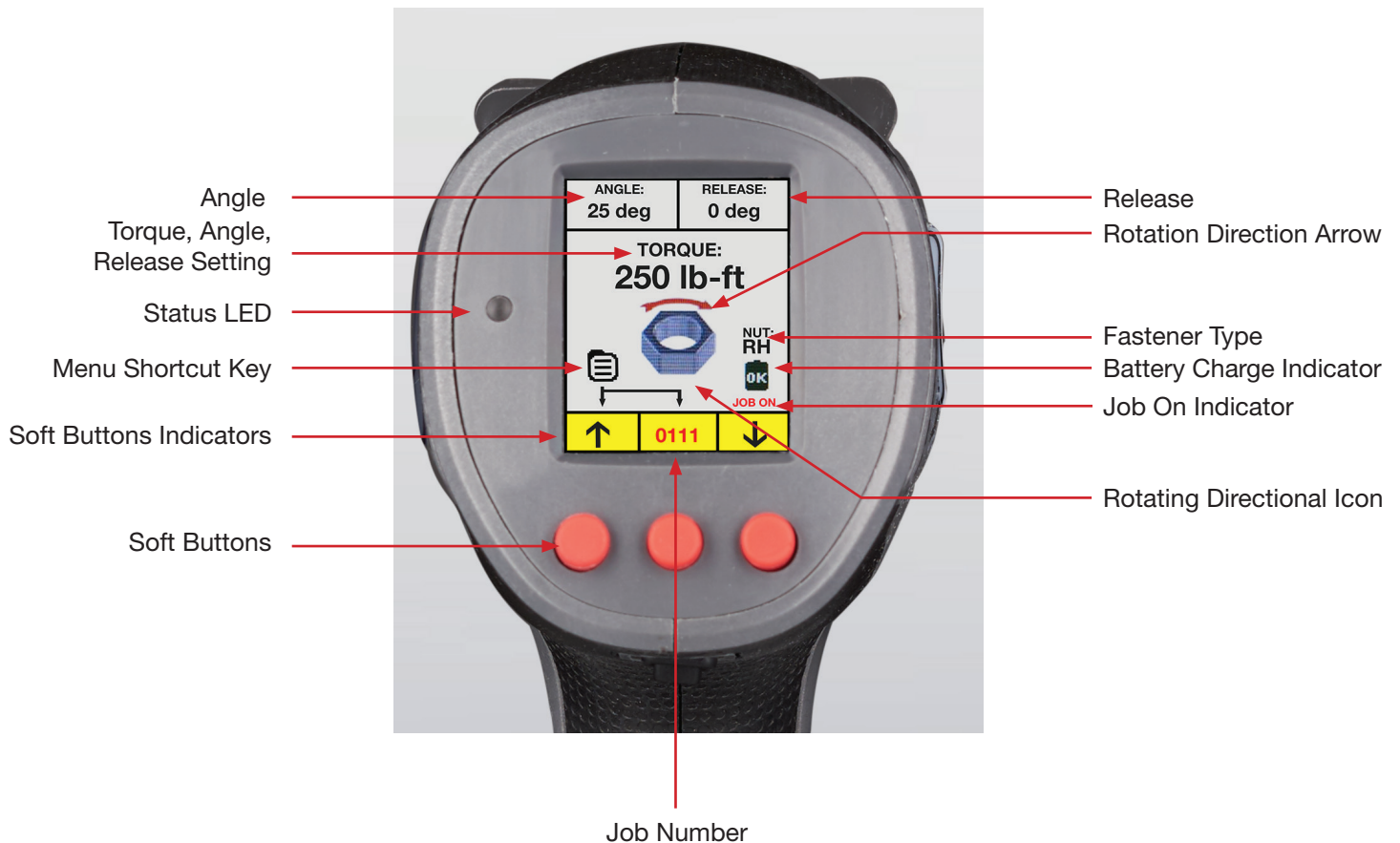

## Setting Torque and Release Angle

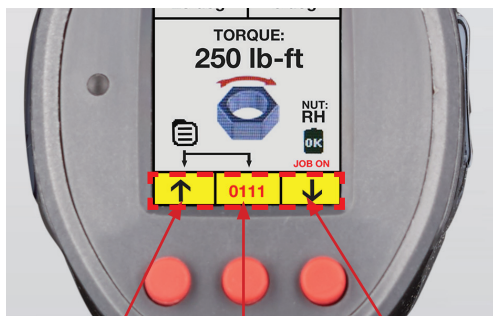

Increase Value

Go to Next Screen

Decrease Value

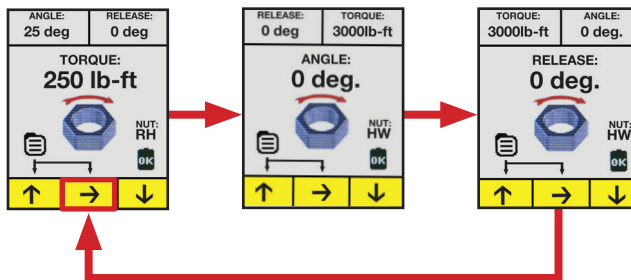

Press and hold center key to toggle through screens for setting Torque, Angle and Release Angle. While on screen, use the up and down arrow keys to select value.

## Basic Function Descriptions

**Torque:** Allows the operator to enter the target torque that the gun will seek when the trigger is pulled and held.

**Angle:** If an angle setting is above “0” the gun will add this angle of rotation to a completed torque operation using the maximum output of the unit.

**Release Angle:** After completing an operation, the gun will automatically run backwards to the specified angle to release windup from reaction torque. This will allow the operator to remove the tool without loosening the fastener.

## LION GUN OPERATION

### Tightening

1. Use the options menu to specify the type of fastener being used.
2. Set the tool to the desired torque level.
3. Set the tool to the desired post-torque angle. (**REMEMBER:** the gun will apply AT LEAST its maximum rated torque while turning the fastener through this requested angle. Accidental application of this post-torque angle feature, or accidental retorquing of a fastener while using angle feature, can lead to damage of the fastener and fastened equipment.)
4. Set the tool to the desired release angle. (**REMEMBER:** the gun will apply AT LEAST its maximum rated torque while turning the system in the “Loosen” direction. Depending on the reaction arrangement of your system, and the requested release angle, this could cause the fastener itself to loosen.)
5. Make sure the LION Gun and fastener equipment are positioned properly.
6. Make sure the reaction fixture is placed securely (Reaction Arm).
7. Pull the trigger to start the torqueing operation.
8. The tool will torque the fastener until the requested torque value is reached.
9. If a post-torque angle has been set, the tool will turn the fastener to the requested angle after the torqueing operation.
10. If a release angle has been specified the tool will back-off the requested angle at the end of the operation.
11. The tool will now indicate the status of the operation.

### Loosening

1. Use the options menu to specify the type of fastener being used.
2. Make sure the LION Gun and fastener equipment are positioned properly.
3. Make sure the reaction fixture is placed securely (Reaction Arm).
4. Put the tool into loosening mode by pressing the directional control switch. **CAUTION:** the tool will use AT LEAST the maximum rated torque of the tool to loosen the fastener.
5. Pull the trigger to start the loosening operation.
6. Release the trigger to stop loosening the fastener.



#### CAUTION

In reverse direction, the gun is set to the MAXIMUM torque setting in order to loosen the nut. Use extreme caution when running in this mode.

# ACCESS MAIN AND SUB MENUS

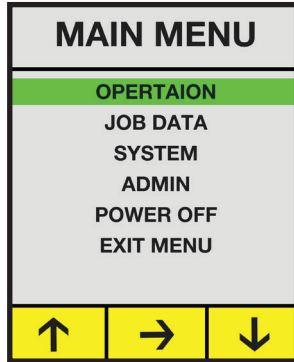

Press and hold left and center buttons simultaneously for approximately 3-seconds, release buttons when the “MAIN MENU” header appears.

The green bar highlights the current position.

Push the left button to scroll down ↓, right button to scroll up ↑

Press the center → button to select and display a sub-menu  
 or to select EXIT MENU to return to Home Display  
 or to select POWER OFF DEVICE to shut off the power immediately.

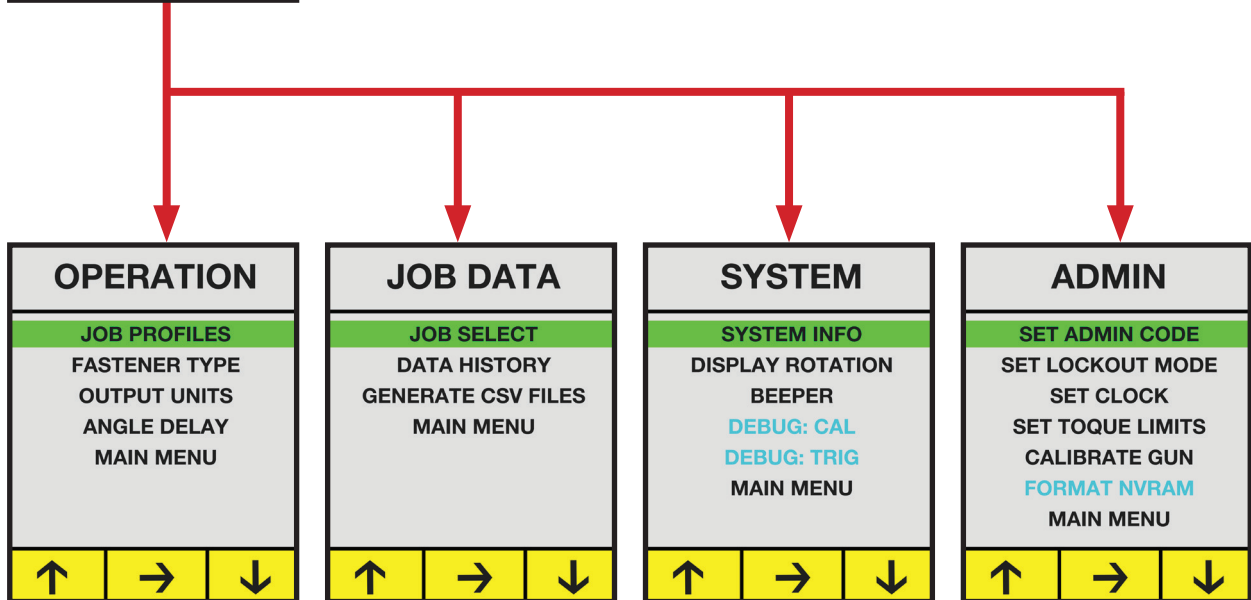

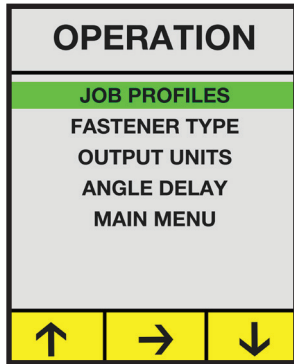

## Operation

The Operation menu contains most functions for every-day operation.

The green bar highlights the current position.

Push the left button to scroll down ↓, right button to scroll up ↑

Press the center → button to select and display a sub-menu or select MAIN MENU to return to Main Menu.

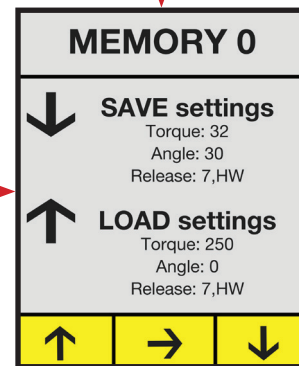
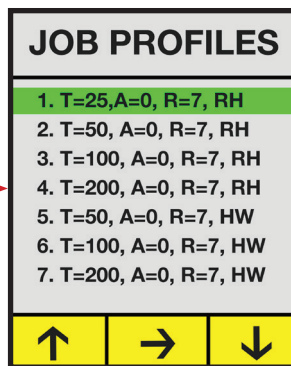
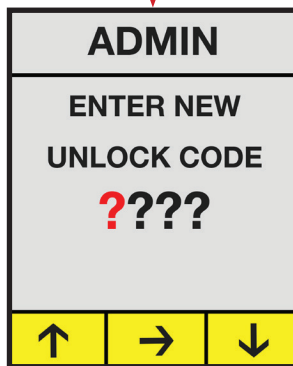

In order to save or load a job profile the user must first enter the 4-digit code to unlock the tool. To enter the code press button ↑ to increase the digit or ↓ to decrease the digit, press → to advance to the next digit until the correct code is entered (default 0000). When the 4-digit code is entered correctly press → again to JOB PROFILES.

**NOTE: Wrong code returns user to previous screen. No limit on number of attempts. See administrator for correct code.**

Allows the user to save tool parameters to memory as a Saved Job Profile (SJP), or to load previously saved parameters (SJPs) from memory. The tool can save up to 8 job profiles; each profile includes saved values for TORQUE (T), ANGLE (A), RELEASE (R) and fastener type. Scroll and select the desired setup values –then select →, or if saving new setup values select →, to access submenu to either SAVE or LOAD settings.

The user can SAVE the settings currently on the home display –now shown in SAVE settings –by pushing the left button ↓ also adds the profile to the top of JOB PROFILES. Alternatively the user can LOAD the selected profile –now shown in LOAD settings –by pushing the right button ↑. Exit without load or save by hitting the center button X. Return to the OPERATION Menu upon completion.

## Operation cont.

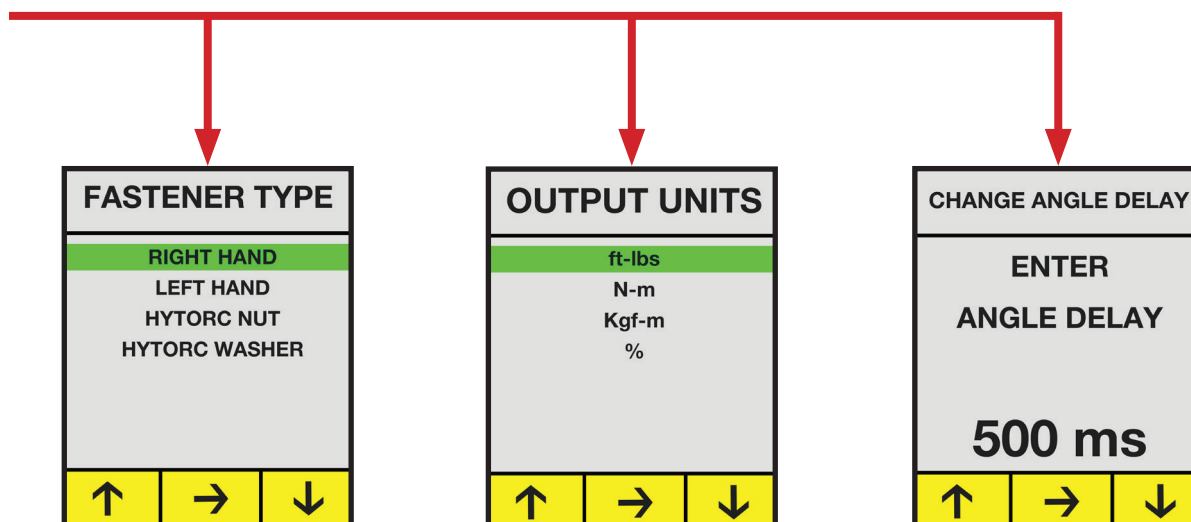

Push appropriate button ↑↓ to scroll up or down, push → select fastener type:

**RH** RIGHT HAND bolts tightened clockwise.  
**LH** LEFT HAND bolts tightened counterclockwise.  
**HN** HYTORC NUT tightened counterclockwise.  
**HW** HYTORC WASHER tightened clockwise.

Any selection → returns users to OPERATION menu.

**NOTE: When HYTORC WASHER is selected, the safety feature requiring a push of the button before operation is disabled. Tool should never be used with a reaction arm in this setting.**

Allows the operator to select the preferred units of the torque display. Press buttons to scroll ↑ or ↓ to highlight the desired units, press → to select desired units and return to the OPERATION menu.

The user can adjust the time delay for applying the ANGLE and RELEASE following the TORQUE operation –the delay can range from 0ms to 3000ms. The time delay is applied after the TORQUE value by continuing to hold the trigger. Push up button ↑ to increase the delay or down button ↓ to decrease the delay. Select → to return to the OPERATION menu.

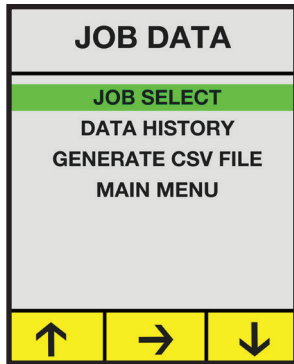

## Job Data

The Job Data menu contains settings needed to record and download data from the tool.

The green bar highlights the current position.

Push the left button to scroll down ↓, right button to scroll up ↑

Press the center → button to select and display a sub-menu or select MAIN MENU to return to Main Menu.

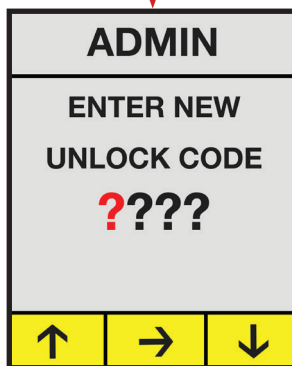

In order to record data the user must first enter the 4-digit UNLOCK CODE to unlock the tool. To enter the code press ↑ to increase the digit or ↓ to decrease the digit, press → to advance to the next digit until the correct code is entered (default 0000). When the correct 4-digit code is entered press → again to proceed to JOB SELECT MODE.

**NOTE: Wrong code returns user to previous screen. No limit on number of attempts. See administrator for correct code.**

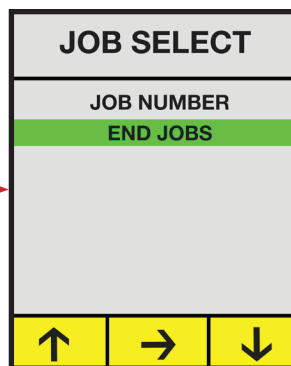

User selects JOB NUMBER to turn on data recording for a particular job. After selecting JOB NUMBER the user is prompted to enter a 4 digit job number. Alternatively the user may select END JOBS to stop recording. Press the buttons ↑↓ to scroll up or down to the desired JOB SELECT mode and press → to select.

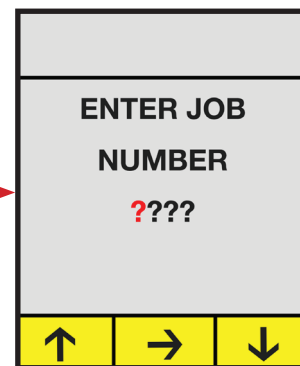

When JOB NUMBER is selected the user is prompted to enter a 4 digit JOB NUMBER (0001 to 9999) for identifying a particular set of job data. To enter the job number press ↑ to increase the digit or ↓ to decrease the digit, press → to advance to the next digit until the full 4 digit code is entered. Press → again to complete entry of the JOB NUMBER and return to the the JOB DATA menu. JOB ON and JOB NUMBER are now displayed on the home screen to indicate the tool is now recording all job data.



## Job Data cont.

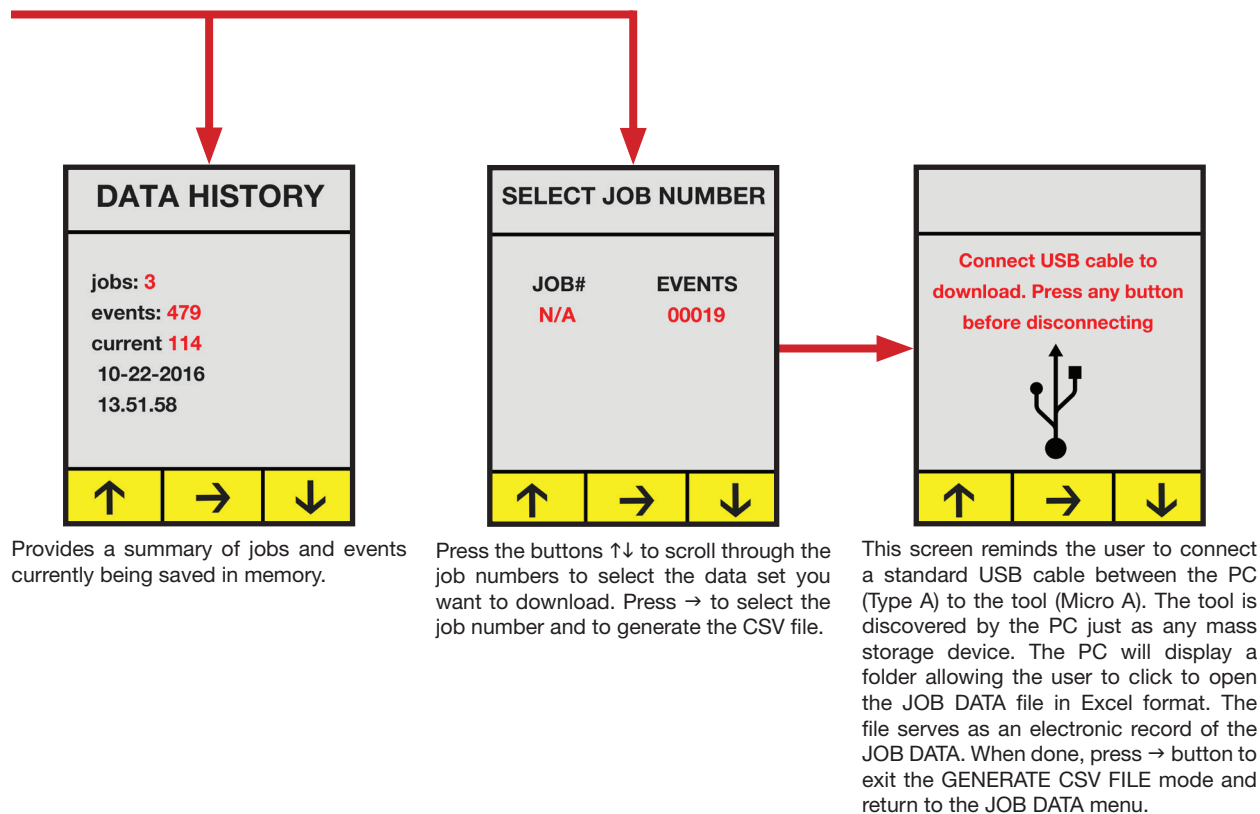

Provides a summary of jobs and events currently being saved in memory.

Press the buttons ↑↓ to scroll through the job numbers to select the data set you want to download. Press → to select the job number and to generate the CSV file.

This screen reminds the user to connect a standard USB cable between the PC (Type A) to the tool (Micro A). The tool is discovered by the PC just as any mass storage device. The PC will display a folder allowing the user to click to open the JOB DATA file in Excel format. The file serves as an electronic record of the JOB DATA. When done, press → button to exit the GENERATE CSV FILE mode and return to the JOB DATA menu.

## Job Data cont.

When the JOB DATA recording is started, the Home Display provides visual indicator for

JOB ON

and the

JOB NUMBER

### Recording Indicator



### Connect Standard USB Cable

When the Tool is powered ON, the USB is connected to a PC, and GENERATE CSV FILE JOB NUMBER selected, the PC discovers the tool just as any other mass storage device. The CSV file automatically appears on the PC in Excel format by default and can be opened or saved as a part of the permanent JOB DATA record.

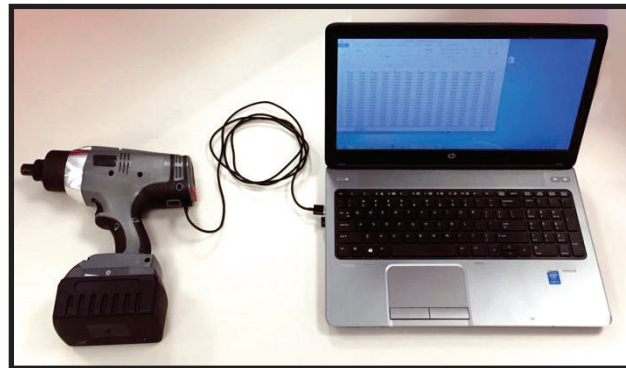

### Sample CSV file in Excel (default).

DATE	TIME	EVENT	TORQUE	ANGLE	RELEASE	JOB	DURATION	TEMP	VOLTAGE	TL	FASTENER	UNIT	COMPCODE
16-10-10	10:45:58	2	27	0	0	101	1	25	20	TIGHTEN	RH	lb-ft	Torque OK.
16-10-10	10:46:20	2	27	0	0	101	17	25	20	TIGHTEN	RH	lb-ft	Torque OK.
16-10-10	10:46:49	2	27	0	0	101	1	25	20	TIGHTEN	RH	lb-ft	Torque OK.
16-10-10	10:46:54	2	27	0	0	101	3	25	20	TIGHTEN	RH	lb-ft	Torque OK.
16-10-10	10:47:00	2	27	0	0	101	2	30	20	LOOSEN	RH	lb-ft	Torque OK.
16-10-10	10:47:05	2	27	0	0	101	2	30	20	LOOSEN	RH	lb-ft	Torque OK.
16-10-10	13:53:51	2	100	100	100	101	9	25	19	TIGHTEN	RH	lb-ft	Torque OK.

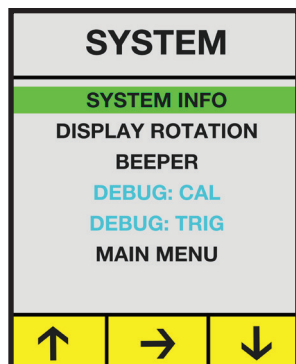

## System

The System menu contains additional settings for tool configuration.

The green bar highlights the current position.

Push the left button to scroll down ↓, right button to scroll up ↑

Press the center → button to select and display a sub-menu or select MAIN MENU to return to Main Menu.

*\*NOTE: DEBUG:CAL and DEBUG:TRIG are not intended for field use. These functions are password protected and only accessible by HYTORC in the factory.*

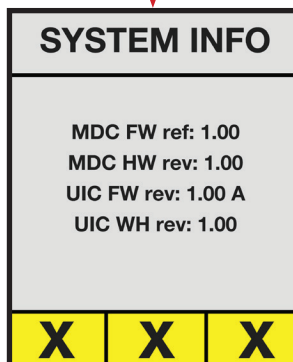

Displays Firmware (FW) and Hardware (HW) versions for MDC (Motor Drive Control) And UIC (User Interface Control). Press any button to return to SYSTEM menu.

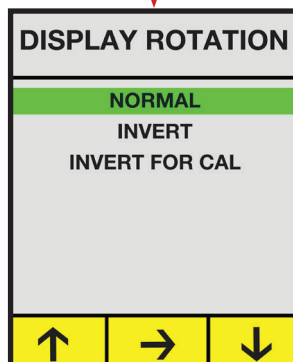

Provides capability to orient the display in normal or inverted mode:

**NORMAL** Screen is legible when battery is down.  
**INVERT** Screen is legible when battery is up.  
**INVERT FOR CAL** Inverted for calibration.

Scroll down ↓ or scroll up ↑ to reach desired orientation for the display and push → to select the orientation and return to the SYSTEM SETTINGS menu

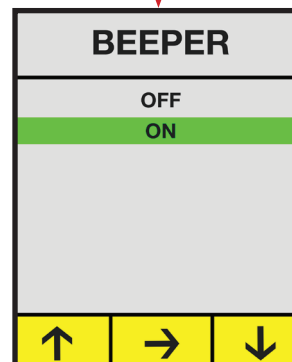

The user can optionally enable or disable the beeper. Press buttons to scroll ↑ or ↓ to highlight the desired state for the beeper, press → to select beep OFF or ON and return to the ADMIN menu. If turned on the beeper will sound 1 time for each successful operation and 4 times to indicate an error.

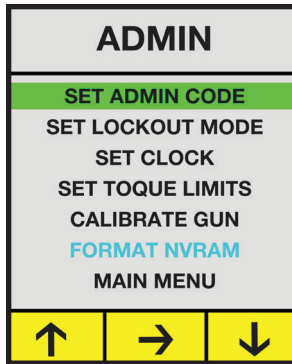

## Admin

The Admin menu contains less seldom used features or those typically only configured by an administrator or supervisor.

The green bar highlights the current position.

Push the left button to scroll down ↓, right button to scroll up ↑

Press the center → button to select and display a sub-menu or select MAIN MENU to return to Main Menu.

*\*NOTE: FORMAT NVRAM is not intended for field use. This function is password protected and only accessible by HYTORC in the factory.*

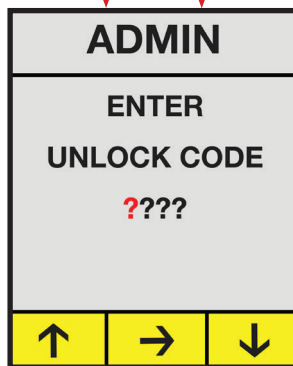

User must first enter the 4 digit unlock code for access to admin features. The default code is 0000. To enter the unlock code press ↑↓ buttons to change the digits in each position to match the code -press → to advance to the next digit. When all digits match the code press → to display ADMIN menu -all functions in the menu are now available.

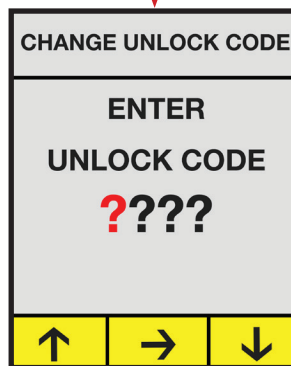

Allows the user to change the 4 digit unlock code required for access to features. Enter the new 4 digit code by pressing the ↑↓ to set a new digit in each position, press → to advance to the next to position. Once the entire NEW CODE has been entered, press → to go to the ADMIN screen, make a note of the NEW CODE.

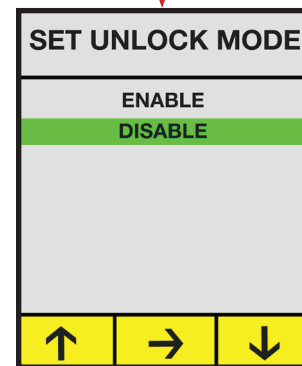

The user may enable a lockout mode that prevents any user from changing any parameter except directional control. This allows the administrator to lock the tool at desired settings for various users. Press the buttons ↑↓ to scroll to ENABLE or DISABLE lockout mode, press → to select LOCKOUT MODE and return to the ADMIN menu.

## Admin cont.

Sub-Menus continued on next page.

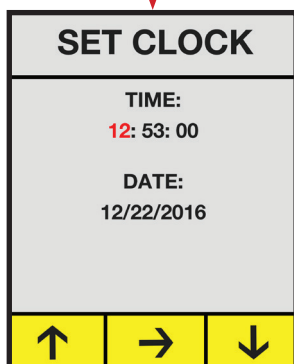

Allows user to set time and date by entering appropriate numerical values.

Push up button ↑ increases the value and down button ↓ to decrease the value, select → to advance to the next numerical value, after setting year push → to return to SYSTEMS SETTINGS menu

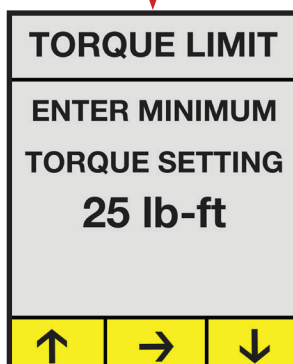

To adjust the minimum TORQUE limit press button ↑ to increase the value or ↓ to decrease the value.

Press → to save the lower torque limit – screen flashes “Saving setting” and then displays the upper torque limit screen.

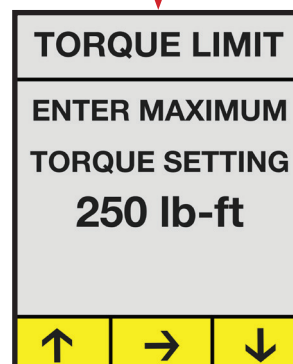

To adjust the maximum TORQUE limit press button ↑ to increase the value or ↓ to decrease the value.

Press → to save the upper torque limit – screen flashes “Saving setting” and then exits to ADMIN menu.

## Calibration

Each Tool is Calibrated with Torque Calibration Equipment in the Factory before shipment.

- Recalibration is recommended at least once a year, or more often for higher use or when changing fastener types.
- Note: Calibration is usually done with the RH fastener selected for consistency.
- Calibration should only be done by qualified personnel according to HYTORC process.

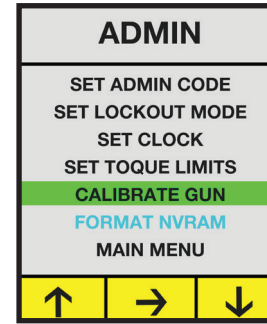

The Calibration menu may be reached by selecting CALIBRATE GUN in the ADMIN menu.

Sub-Menus continued from previous page.

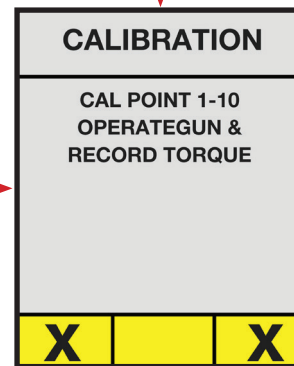

Shortcut: The Calibration menu may also be accessed with a Shortcut. Press and hold Right and Center Buttons approximately 3-seconds and release to display the Calibration Menu. Note if the Unlock code has not been entered yet in the session, the operator will be presented with the ADMIN screen and asked for the unlock code before directing them to the Calibration menu.

The Tool is installed in the Calibration Equipment which is set at a known torque calibration point. The tool is operated in the calibration fixture until it stalls at the calibration point. When the tool stalls the calibration equipment provides a measured Torque value. The tool displays the next menu prompting the operator to enter the measured value. If the user does not want to calibration press the left or right button X to exit and the Calibration sequence is canceled.

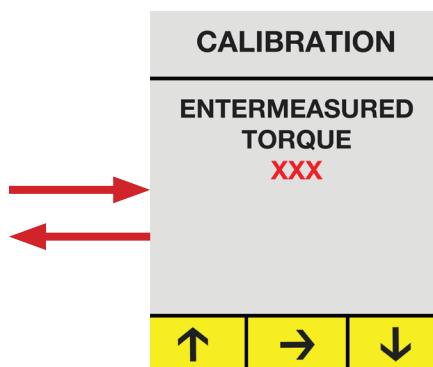

The Torque value measured by the calibration equipment is entered into the tool. To enter the value press left or right  $\uparrow\downarrow$  buttons to change the digits in each position to match the measured value, press  $\rightarrow$  to advance to the next digit. Press  $\rightarrow$  again after the last digit to return to the previous menu and run the tool at the next calibration point in the sequence. This procedure is repeated for all calibration points (typically 1 to 10) allowing the measured value to be entered into the tool at each calibration point.

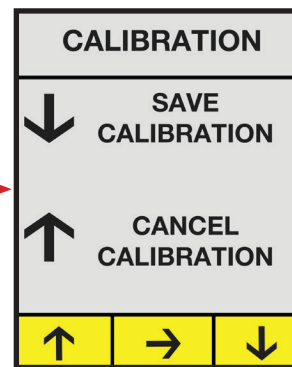

Following entry of the last (maximum) calibration point a menu appears to allow the calibration values to be saved in the tool. Select SAVE to complete the calibration process or CANCEL to return to the ADMIN menu. Note: Following the calibration process the tool is again tested against known calibration values to ensure accuracy  $\pm 5\%$ . A calibration sticker is affixed to the tool providing date of calibration and due date for next calibration.

## SHORTCUTS

### MAIN SCREEN BUTTON SHORTCUTS:

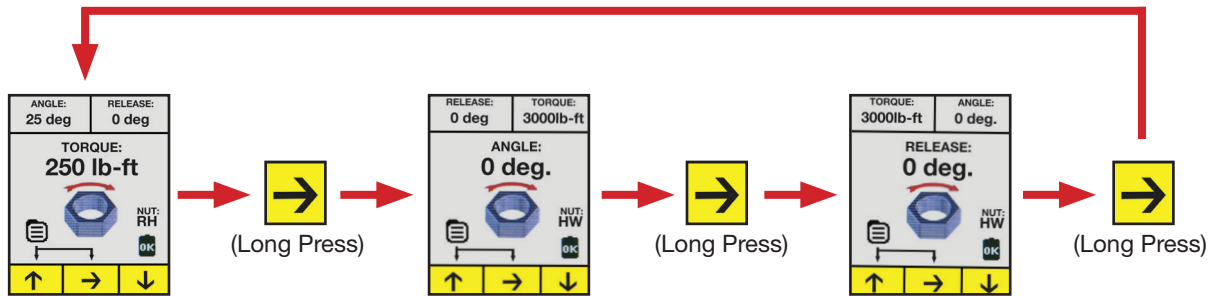

### GETTING TO THE OPTIONS MENU

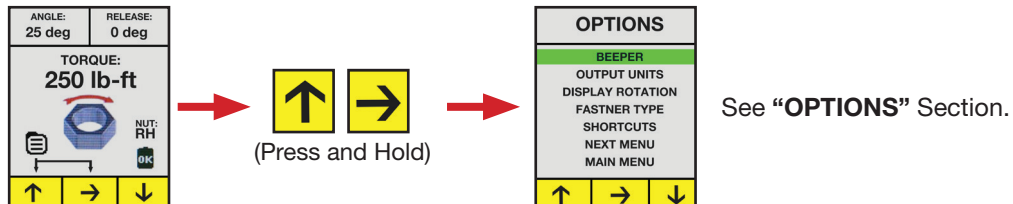

### CALIBRATION

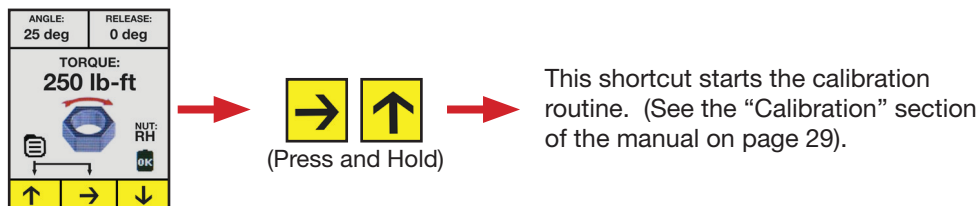

### MEMORY

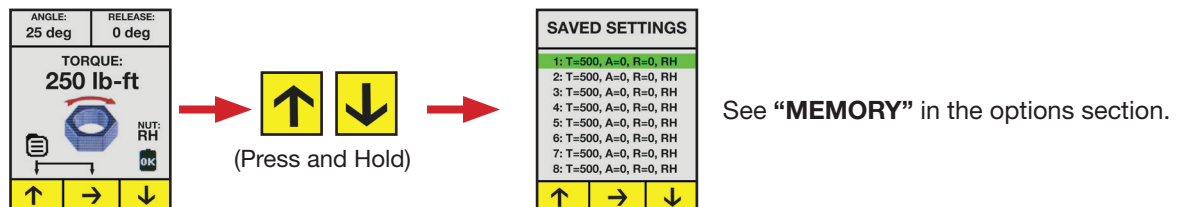

## ***MAINTENANCE***

### **Preventive Maintenance**

Even though the LION Gun can operate virtually maintenance free; good care, proper repairs and preventive maintenance will contribute significantly to longer lasting tool life.

- Sufficient cooling must always be ensured. The cooling vents must be kept clean, free of adhering dirt and dust, and may not be closed for any reason.
- Keep tools clean and protected from damage.
- Have worn or damaged fittings or cords replaced.



**WARNING!**

During maintenance, the power supply must be disconnected.  
Damaged power cables or cords can be hazardous.



# CALIBRATION

Calibration should be done by a qualified technician. For standard bolting work, calibration must be done on a soft joint fixture. The LION Gun can collect and average many samples for each calibration point.

1. Enter the desired number of samples to be taken per calibration point by changing the **“CALIBRATION SAMPLES”** value in the options menu.
2. Enter calibration mode through the **OPTIONS** menu or by pressing, and holding, the middle and right buttons simultaneously.
3. Enter the unlock code (default code is “0000”).
4. Enter optional release angle.
5. Calibration routine will now begin: Be aware, the gun will now operate **WITHOUT** prompting the operator to also press one of the back buttons.
  - When “Cal Point X – Y Operate Gun & Record Torque” is displayed: (**Note:** X = the current calibration point, Y = the current sample of the calibration point).
    - Pull and hold the trigger.
    - The gun will torque until it reaches its calibration point.
    - When it stops, enter the final torque using the rear buttons.
  - The gun will now temporarily store this calibration point.
  - Repeat at the gun prompts.
6. When all calibration points are completed, the torque gun will ask if you would like to save or cancel. If you select **“SAVE”**, the temporary calibration data will now be locked into memory.

**Note:** If the first calibration point generated torque values **ABOVE** the minimum rated torque for the tool you are calibrating, the calibration has failed. If by the **LAST** calibration point, the gun failed to generate torque that **EXCEEDS** the maximum rated torque of the gun, the calibration has failed. In either case please contact HYTORC or support.

7. When all calibration points are completed, the torque gun will ask if you would like to save or cancel. If you select **“SAVE”**, the temporary calibration data will now be locked into memory.

**Note:** If the first calibration point generated torque values **ABOVE** the minimum rated torque for the tool you are calibrating, the calibration has failed. If by the **LAST** calibration point, the gun failed to generate

APPENDIX A

## LION GUN BLOCK DIAGRAM

LION Gun 18V Block Diagram

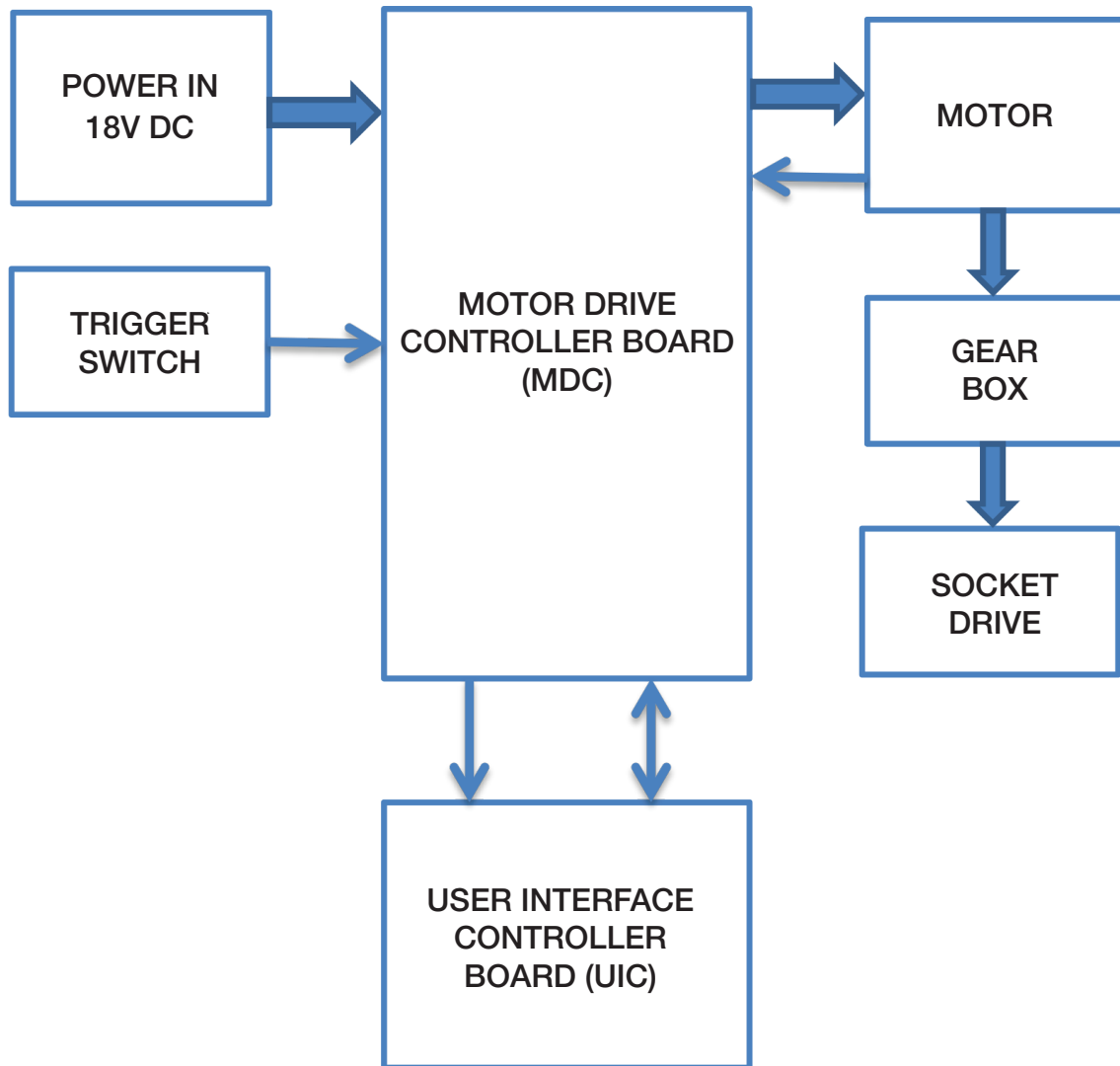

APPENDIX B

## LION GUN DIMENSIONS

LION Gun Dimensions

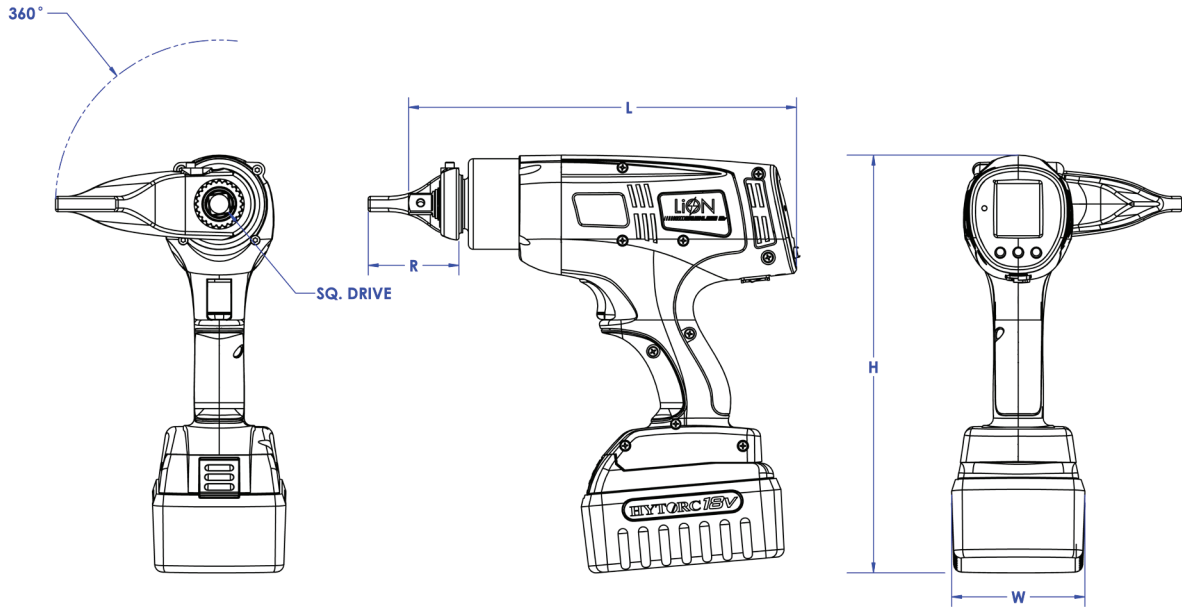

	Torque Range	Drive	H	L	W	R	RPM (No Load)	Final Torque RPM	Weight (With Battery)
Model	Ft. Lbs./Nm		Inches/cm						Lbs./Kg
<b>LION-.25</b>	25-250/47-441	½"	10.83"/27.50	10.16"/25.80	3.46"/8.79	2.45"/6.22	11.6	8.7	7.3/3.3
<b>LION-.7</b>	150-700/203-950	¾"	10.83"/27.50	10.8"/27.43	3.46"/8.79	2.86"/7.26	3.9	2.9	8.22/3.72



**HYTORC WORLD HEADQUARTERS**  
MAHWAH, NJ, +1-201-512-9500

## **WORLDWIDE LOCATIONS**

**ADVANCED BOLTING SOLUTIONS PVT. LTD**  
MAHAPE, MB, +91-22-4171-4444

**HYTORC BRAZIL**  
RIO DE JANEIRO, BR, +55-21-2621-1911

**HYTORC OF CHINA**  
SHANGHAI, +86-21-6254-0813

**HYTORC MIDDLE EAST**  
UAE, +44-7436-549468

**HYTORC CENTRAL EUROPE & RUSSIA**  
PERCHTOLDSORF, AU, +43-1-86-51-368

**HYTORC JAPAN**  
SUGINAMI-KU, TYO, +81-3-3314-3315

**HYTORC UK**  
CRAMLINGTON, NB, +44-1-670-363800

**HYTORC OF KOREA**  
KYUNGGI-DO, +82-31-708-0850

**HYTORC AUSTRALIA**  
ADELAIDE, AUS +61-8-8293-8411

**HYTORC SOUTH AFRICA**  
MOUNT EDGECOMBE, DUR, +27-(0)315023119

**HYTORC SINGAPORE**  
SINGAPORE, +65-689-789-95

**HYTORC LATIN AMERICA**  
MARIA DE LA PIEDAD, CTZ, +52-921-21-52760

**HYTORC has representatives in every area of  
the world. To find your nearest location visit:**

[hytorc.com/world](http://hytorc.com/world)

E: [info@hytorc.com](mailto:info@hytorc.com)  
P: +1-201-512-9500